



## **FCC Compliance**

This equipment has been tested and found to comply with the limits for a Class A digital device, pursuant to part 15 of the FCC rules. These limits are designed to provide reasonable protection against interference when the equipment is operated in a commercial environment. This equipment generates, uses, and can radiate radio frequency energy and, if not installed and used in accordance with the instruction manual, may cause interference to radio communications. Operation of this equipment in a residential area is likely to cause interference, in which case the user will be required to correct the interference at his own expense. Use only a shielded interface cable to operate this equipment with a printer or other peripheral device.

**CAUTION:** Changes or modifications to this equipment not expressly approved by the party responsible for compliance (Pitney Bowes) could void the user's authority to operate the equipment.

## Canada EMC Compliance

This Class A digital apparatus complies with Canadian ICES-003.  
Cet appareil numérique de la classe A est conforme à la norme NMB-003 du Canada.

SV61369 Rev. C April 2005

©2005 Pitney Bowes Inc. All rights reserved. This guide may not be reproduced in whole or in part in any fashion or stored in a retrieval system of any type or transmitted by any means, electronically or mechanically, without the express, written permission of Pitney Bowes.

We have made every reasonable effort to ensure the accuracy and usefulness of this manual; however, we cannot assume responsibility for errors or omissions or liability for the misuse or misapplication of our products.

Due to our continuing program of product improvement, equipment and material specifications as well as performance features are subject to change without notice. Your inserter system may not have some of the features described in this book.

E-Z Seal is a registered trademark of Pitney Bowes Inc. ENERGY STAR is a registered trademark of the United States Environmental Protection Agency.

Printed in the USA or Canada.

### Important Safety Notes

Follow these basic safety precautions when operating this machine:

- Read all instructions before you attempt to operate the system.
- Use this equipment only for its intended purpose.
- Place the system close to an easily accessible wall outlet.
- Place the system in an accessible location to allow for proper venting of the equipment and to facilitate servicing.
- Use the power cord supplied with the machine and plug it into a properly grounded wall outlet that is located near the machine and easily accessible. Failure to properly ground the machine can result in severe personal injury and/or fire.
- The power cord wall plug is the primary means of disconnecting the machine from the AC supply.
- DO NOT use a wall outlet controlled by a wall switch or one that is shared with other equipment.
- DO NOT use an adapter plug on the line cord or wall outlet.
- DO NOT remove the ground pin from the line cord.
- Make sure the area in front of the wall outlet into which the machine is plugged is free from obstruction.
- DO NOT route the power cord over sharp edges or trap it between pieces of furniture. Make sure there is no strain on the power cord.
- To reduce the risk of fire or electrical shock, DO NOT attempt to remove covers or disassemble the control panel or its base.
- If the unit becomes damaged, unplug it from the wall, then contact your Customer Service Representative.
- Keep fingers, long hair, jewelry and loose clothing away from moving parts at all times.
- Avoid touching moving parts or materials while the machine is in use. Before clearing a jam, be sure machine mechanisms come to a complete stop.
- Remove jammed material gently and carefully.
- Do not place lighted candles, cigarettes, cigars, etc., on the system.
- To prevent overheating, do not cover vent openings.

## ***Quick Start Guide***

---

- Use only approved supplies, in particular aerosol duster. Improper storage and use of aerosol dusters or flammable aerosol dusters, can cause an explosive-like condition that could result in a personal injury and/or property damage. Never use aerosol dusters labeled flammable and always read instructions and safety precautions on the duster container label.
- To obtain supplies and/or Material Safety Data Sheets, contact your Customer Service Representative.
- Operation of this equipment without periodic maintenance will inhibit optimum operating performance and could cause the equipment to malfunction. Contact your Customer Service Representative for the required service schedule.
- Always follow specific occupational safety and health standards for your workplace.
- To reduce the risk of fire or electrical shock, DO NOT attempt to remove covers or disassemble the control panel or its base. The cabinet encloses hazardous parts.

## Machine Identification

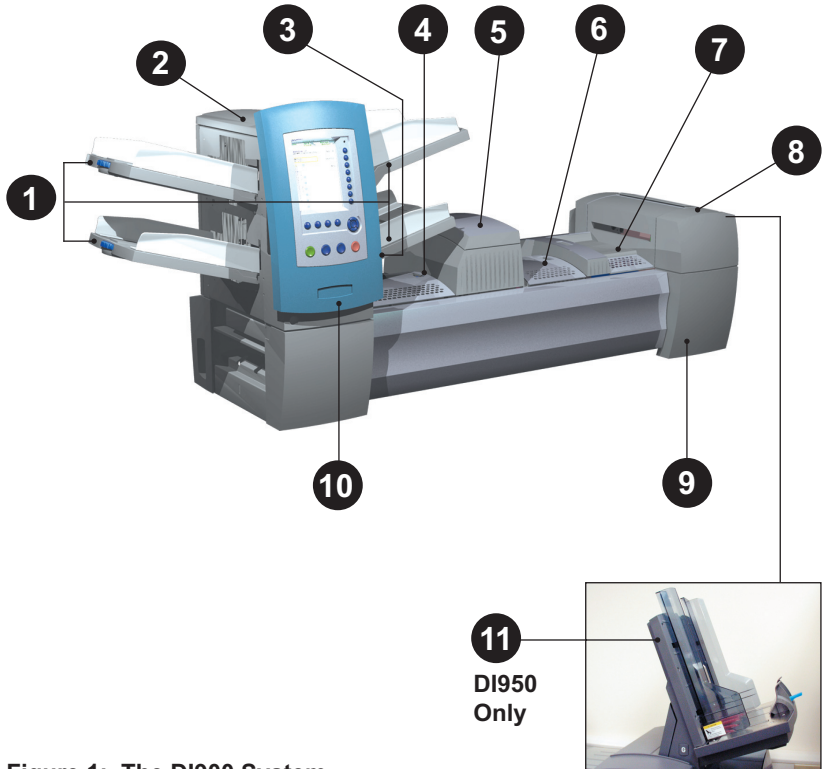

Figure 1: The DI900 System

### Legend

- 1** **Tower Feeder Trays** - feed sheets and/or inserts to the Feeder Tower.

---

**NOTE:** If enabled, the lower left Tray is assigned with the letter "A" on the Mail Piece Icon Tree. When a high capacity envelope feeder is not part of the system configuration, this Tray is the primary Tray for feeding envelopes designated for a given job.

---

- 2** **Feeder Tower** - is a two-sided Tray holder/material feeder.

## Quick Start Guide

---

- 3 **Manual Feeder** - allows you to manually feed stapled or unstapled sets of up to 5 sheets of 20 lb (80gsm) paper. The machine waits for each set to be manually fed before folding and inserting the set automatically into the envelope. The Manual Feed option is available during job creation. Inserts and/or Sheets from other Trays can also be added to the job.
- 4 **Pre-fold Accumulator** - is a staging area for the material that needs to be collated together and then sent to the Folder unit.
- 5 **Folder** - applies one of the available fold types to Sheets.
- 6 **Post-fold Accumulator** - is a staging area for the folded Sheets to meet any inserts that are to be included.
- 7 **Insertion Area** - is the part of the transport where the collation intended for a single addressee is inserted into an outer envelope.
- 8 **Moistener, Closer, Sealer** - Brushes sweep across the envelope flap to wet the glued area of the flap. The envelope then moves through the Closer and Sealer areas of the unit to complete the mail piece.
- 9 **Sealing Solution Bottle** - is located inside an opening cover at the front right side of the machine. It provides sealing solution to the envelope sealing system.
- 10 **Control Panel** - allows you to run the machine and configure job settings. It also displays the machine status and shows loading instructions and details of the job. See the following pages for more information on the controls and screen.
- 11 **High Capacity Envelope Feeder (DI950 only)** - holds at least 500 letter-sized envelopes. It feeds directly to the Insertion Area.

**Drop Stacker (available on all units, not illustrated) or Power Stacker (Optional, not illustrated)** - collects and neatly stacks the finished mail pieces that exit the system. The drop stacker can be unlatched from the system when it is not needed. The power stacker is mounted to the system.

## Control Panel

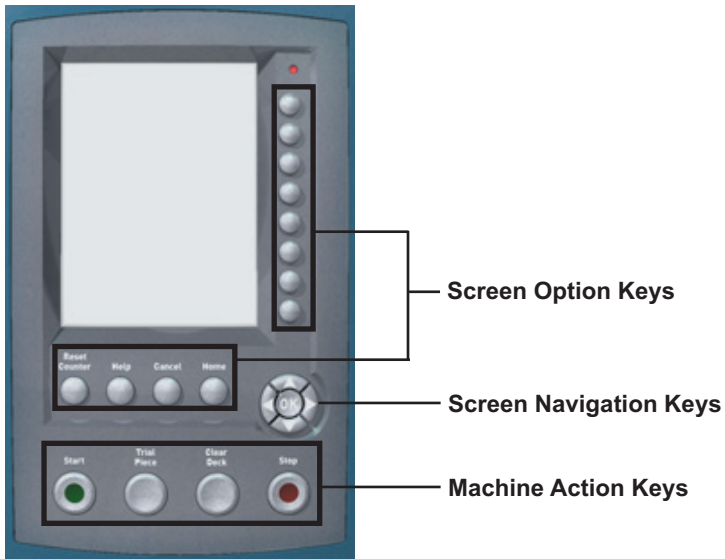

### Screen Option Keys

Use the **8 keys on the right side of the screen** to:

- Highlight an item in a displayed pick list and/or
- Select the associated menu, item, action, or option.

Use the **4 keys along the bottom of the screen** to perform the stated action:

- **Reset Counters** accesses the Reset Counters screen that allows you to zero the Piece Counter or reset the Batch count.
- **Help** accesses information about the screen that currently displays and it provides access to the Help Topic Index that allows you to navigate to other topics.
- **Cancel** returns you to the previous screen. If you have made changes or defined settings on the screen you are cancelling, these will be lost.
- **Home** returns you to the Home screen. The Home screen is the starting point for running a job. Once you select “Home” changes you made prior to selecting “Home” will be saved.

# Quick Start Guide

---

## Screen Navigation Keys

- Use the **UP/DOWN** and **LEFT/RIGHT** Arrow Keys to move the highlight on the screen in those directions.
- Press **OK** whenever you want to apply a selection that you made using the Arrow Keys.

## Machine Keys

Use the **4 keys along the bottom of the Control Panel** to run the system and control its mechanical movement:

- **Start** causes the selected job to start running.
- **Trial Piece** allows you to do a test run on your job. One complete mail piece will be prepared. This allows you to verify that your job settings are correct, that the mail piece looks the way you want it to look, and that the system is functioning properly.

---

### NOTES:

- Even if the job calls for a sealed mail piece, the trial piece will be unsealed for easy inspection.
  - Double Detect is set for trial pieces, so be sure to examine the contents of the mail piece.
- 
- **Clear Deck** rids the system of materials currently in process in the paper paths.

**NOTE:** Only press CLEAR DECK when prompted by the system to minimize lost material and manual mail piece generation.

---

- **Stop** completes pieces in process.



## Mail Piece Icon Tree



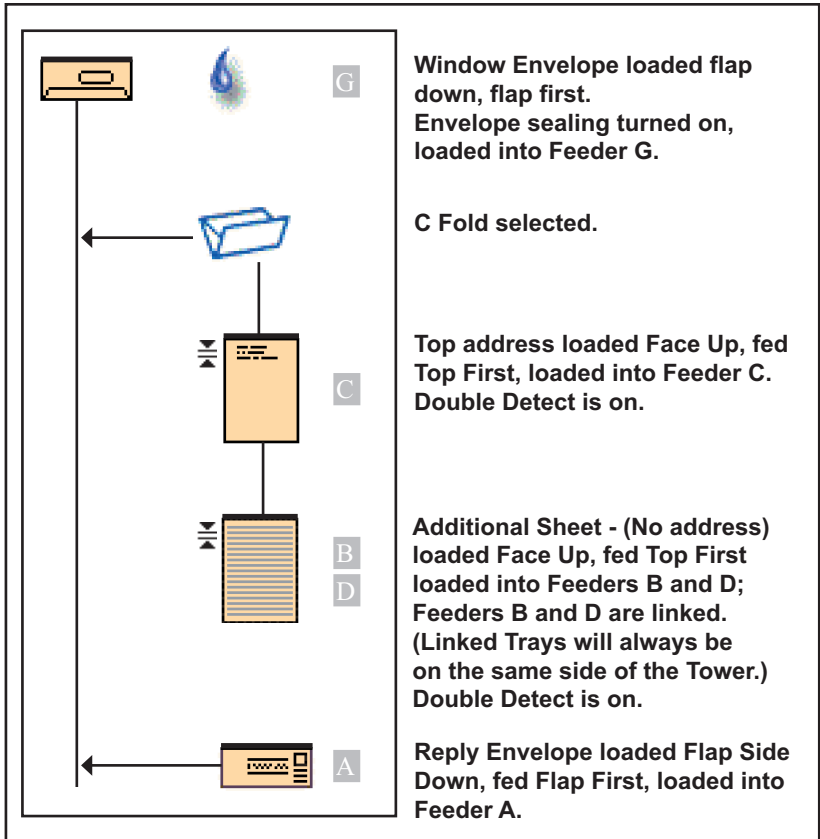









When you run, view, or create a job, a Mail Piece Icon Tree displays on the control panel. An example Mail Piece Icon Tree is shown below. This explains the information that is available and how it assists you in loading and running a job. A list of all the icons is provided on the next page.



Example: Mail Piece Icon Tree

































# Quick Start Guide

## Envelope Icons

	Tower Feeder Orientation: <i>flap side down, flap first.</i>	HCEF* Orientation: <i>flap side down, flap last.</i>
Non-Window Letter Envelope		
Window Standard Flap Envelope		
Window Forward Flap Letter Envelope		
Window Bottom Flap Letter Envelope		
Non-Window Flat Envelope		N/A
Window Standard Flap Flat Envelope		N/A
Window Forward Flap Flat Envelope		N/A
Window Bottom Flap Flat Envelope		N/A



















**\*High Capacity Envelope Feeder**



## Sheet Icons



	<b>Orientation:</b> <i>face up, top first.</i>	<b>Orientation:</b> <i>face up, bottom first.</i>	<b>Orientation:</b> <i>face down, top first.</i>	<b>Orientation:</b> <i>face down, bottom first.</i>
Sheet, Not Personalized				
Sheet, Top Address				
Sheet, Middle Address				
Sheet, Bottom Address				
Multiple Sheets, Not Personalized				
Multiple Sheets, Top Address				
Multiple Sheets, Middle Address				
Multiple Sheets, Bottom Address				

# Quick Start Guide

## Insert Icons

	<b>Orientation:</b> <i>face up, top first.</i>	<b>Orientation:</b> <i>face up, bottom first.</i>	<b>Orientation:</b> <i>face down, top first.</i>	<b>Orientation:</b> <i>face down, bottom first.</i>
Slip or Generic Insert				
Reply Envelope		N/A	N/A	N/A
Reply Card				
Multiple Slips or Generic Inserts				
Multiple Reply Envelopes		N/A	N/A	N/A
Multiple Reply Cards				



	<b>Orientation:</b> <i>closed edge first.</i>
Pre-Folded Insert	
Multiple Pre-Folded Inserts	

	<b>Orientation:</b> <i>bound edge first.</i>
Letter Booklet	
Multiple Letter Booklets	

## Feeder Assignment Icons

Feeder assignment is indicated by a letter in a grey square to the right of the job item icon in the Mail Piece Icon Tree. The letter that appears in the grey square will vary, depending upon the assigned feeder.





**Single Feeder Assignment** is indicated by one grey square. 

**Linked Feeder Assignment** is indicated by two grey squares.   

**NOTE:** The table below provides a list of all possible Feeder assignments. The Feeders available to you will vary, depending upon your system configuration.

Feeder Letter	Location	Position
A	Feeder Tower	Bottom left feeder
B	Feeder Tower	Bottom right feeder
C	Feeder Tower	Top left feeder
D	Feeder Tower	Top right feeder
G	High Capacity Envelope Feeder (HCEF)	N/A
J	High Capacity Sheet Feeder 1 (HCSF)	Bottom feeder
K	High Capacity Sheet Feeder 1 (HCSF)	Top feeder
L	High Capacity Sheet Feeder 2 (HCSF)	Bottom feeder
M	High Capacity Sheet Feeder 2 (HCSF)	Top feeder





## Fold Icons

No Fold	
C Fold	
Z Fold	
Single Fold	
Double Fold	

# Quick Start Guide

---

## Other Icons

<b>Error Icon</b> - appears in pop-up messages on display screen. Indicates message is an error message.	
<b>Warning Icon</b> - appears in pop-up messages on display screen. Indicates message is a warning message.	
<b>Seal On Icon</b> - appears in Mail Piece Icon Tree if sealing is on.	
<b>Double Detect Icon</b> - appears in Mail Piece Icon Tree if double detect is on.	

## Running a Job

1. From the Home screen, select "Menu", then "Jobs", and finally "Select Another Job". If you do not see the job you need, contact your supervisor to define a new job.
2. Using the Mail Piece Icon Tree on the display as your guide, load the Feeder Trays with materials specified for the selected job:
  - Make sure you fan or aerate the material before loading.
  - Adjust the Side Guides using the Side Guide Adjustor.
3. Make Pre-Run Adjustments. Refer to Operator Guide for detailed steps on each of these procedures:
  - Adjust the Envelope Openers.
  - Adjust (optional) High Capacity Sheet Feeder Guides
  - Adjust (optional) Scan Head
4. If the job requires sealing, make sure the sealer bottle has solution (located under the front right hand side cover of the machine). If necessary, fill the bottle with sealing solution (we recommend Pitney Bowes® E-Z Seal® sealing solution for best results).

5. Press **Trial Piece** to “test run” one mail piece for your job. Refer to the Operator Guide for detailed steps on each of these procedures:
  - Verify the integrity of the mail piece by visually inspecting the “trial piece” to confirm the presence of all materials and accuracy of the collation order.
  - Make needed adjustments and run another trial piece to ensure job accuracy.
7. When the “trial piece” is OK, press **Start** to begin running the job.
8. Be sure to keep the Feeder Trays full with the job-specific material while the machine is running.

### If You Run into Problems

- If an error message appears, follow the prompts on the display. If you cannot resolve the error, contact your supervisor or refer to the Operator Guide on CD.
- If a material stall occurs within the machine, follow the prompts on the display to open the appropriate cover and remove the stalled piece. If necessary, manually advance material through and out of the machine.

---

**NOTE:** The machine has safety interlocks on its covers, whereby the machine will not run when a cover is open. Make sure you close all covers before resuming operation.

---

- Verify you have selected the correct job.
- Verify you have the correct material for your job (inserts, sheets, envelopes).
- Verify your material conforms to the material specifications of the machine (see the Operator Guide).

# Quick Start Guide

---

## If You Need Assistance

- For basic operation questions, use the built-in **Help** file that is accessed with the **Help** key on the Control Panel.
- For more detailed troubleshooting or setup help, consult the Operator Guide on the CD.

## USA Contacts

Product Name - DI900 or DI950

- For frequently asked questions, go to: [www.pb.com](http://www.pb.com) and click on **Customer Support**.
- To place requests for service or training, go to: [www.pb.com](http://www.pb.com) and click on **My Account**.
- To order supplies and accessories, call the Supply Line™ at: 1.800.243.7824 or go to: [www.pb.com](http://www.pb.com) and click on **Online Store**.
- To view and pay invoices online, go to: [www.pb.com](http://www.pb.com) and click on **My Account**.
- To view inventory, go to: [www.pb.com](http://www.pb.com) and click on **My Account**.
- For direct questions, call: 1.800.522.0020.  
Customer Service Representatives are available Monday through Friday, 8:00 AM - 8:00 PM ET.
- To obtain Material Safety Data Sheets, call the Supply Line™ or go to: [www.pb.com](http://www.pb.com) and click on **Customer Support**.

## Canada Contacts

Product Name - DI900 or DI950

- For frequently asked questions or to order supplies, go to: [www.pitneybowes.ca](http://www.pitneybowes.ca)
- For direct questions, call: 1.800.672.6937.  
Customer Service Representatives are available Monday through Friday, 8:30 AM - 4:00 PM ET.







*Engineering the flow of communication™*

1 Elmcroft Road  
Stamford, Connecticut 06926-0700  
[www.pb.com](http://www.pb.com)

5500 Explorer Drive  
Mississauga, Ontario L4W 5C7  
[www.pitneybowes.ca](http://www.pitneybowes.ca)

For Service or Supplies



PB Form SV61369 Rev. C 4/05

© 2005 Pitney Bowes Inc.  
All Rights Reserved  
Printed in the USA



Printed on recyclable paper



\* S V 6 1 3 6 9 R E V C \*